



TIME FOR YOU





### Scandinavian Suite

Copenhagen Bath have in collaboration with award winning designers established Scandinavian Suite as their unique and exclusive collection of products.

The Scandinavian Suite product range is dedicated to classic and modern design and is inspired by the old French word Suite, which allow multiple rooms to be connected as one universe.

## CONTENT

<b>SQ Collection</b>	
SQ2 cabinets	6
SQ1 bathtub	10-11
SQ1 oval bathtub	12-15
<b>Muschel</b>	16-19
<b>TQ5</b>	20-23
<b>Christianssand collection</b>	
Christianssand basin	24
Christianssand bathtub	24-27
<b>Yuno</b>	
Yuno CA	34-35
Yuno LR	36-39
Yuno TA	40-43
Yuno WA	44-47
Yuno Rail	48-51
Yuno Bathtub	52-55
<b>Skagen cabinet</b>	56-59
<b>Bergen cabinet</b>	60-63
<b>Specifications</b>	65-75

STUDIO MIKAL HARRSEN

MILAN | COPENHAGEN

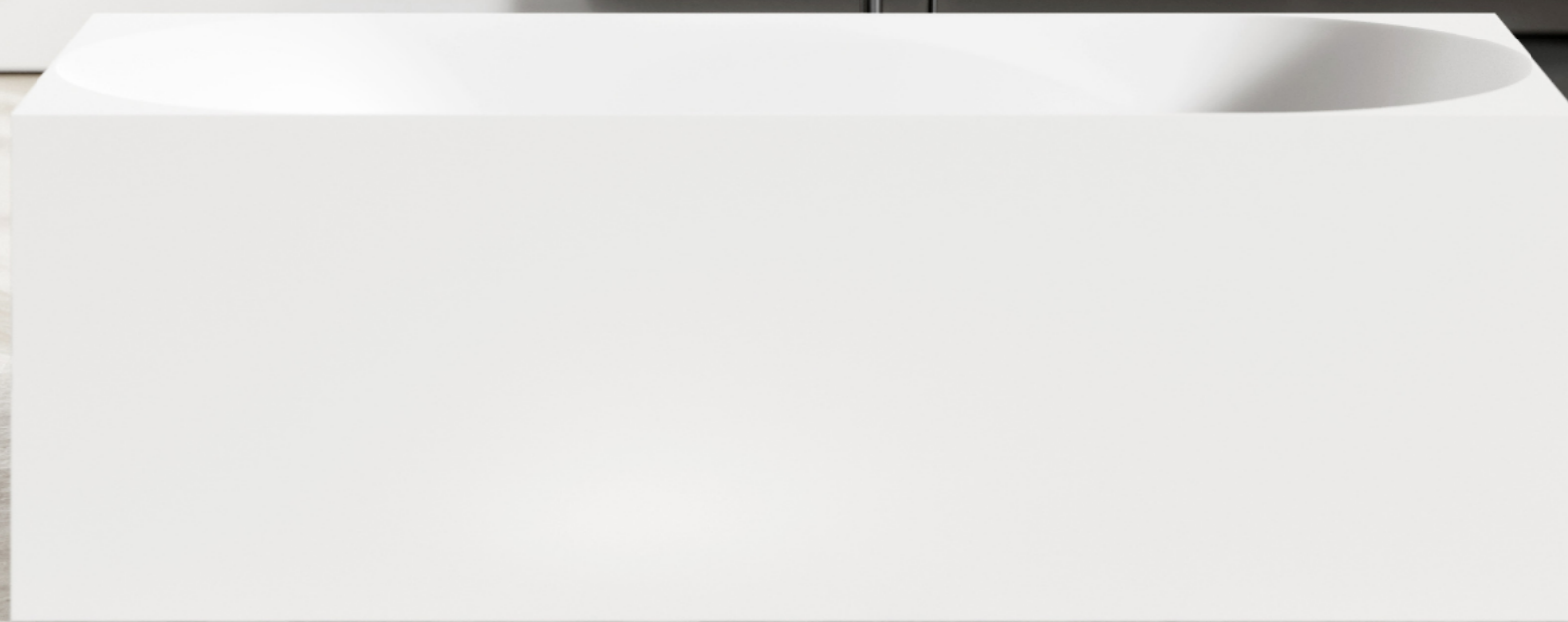
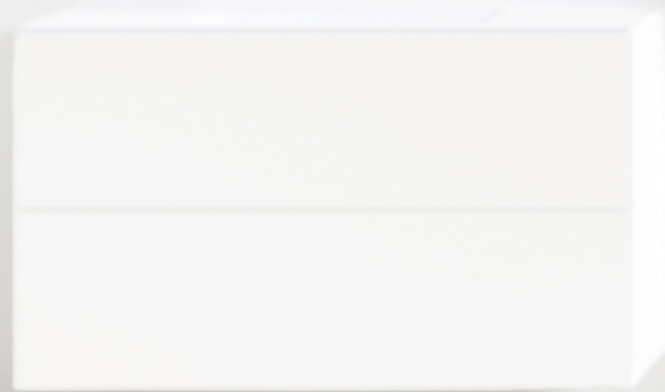
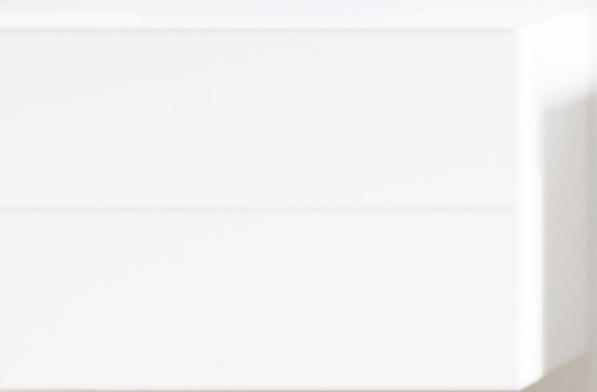

# STUDIO MIKAL HARRSEN

MILAN | COPENHAGEN



Since 2012 Mikal Harrsen has been designing bathroom furniture for Copenhagen Bath. Bathtubs, basins, cabinets and a wide range of accessories which all are a part of the exclusive Copenhagen Bath Scandinavian Suite series.

The idea behind the project was to combine Scandinavian traditions of wellness with an elegant and classic styled design with optimal comfort.

Throughout his career Mikal Harrsen has focused on creating original design solutions for clients and brands with ambitious projects and product portfolios.

Mikal is a designer who lives through visual impressions. Designing an object is like developing a picture - the creative vision is captured mostly through the senses. He regards the design process as the individual filter which he uses when defining a physical form or object for the vision.

## AWARDS

Red Dot Award

IF Design Award

Communication Arts Award,

ADEX Platinum (American Design Award of excellence)

Design Prize of the Federal

Republic of Germany (nominee)

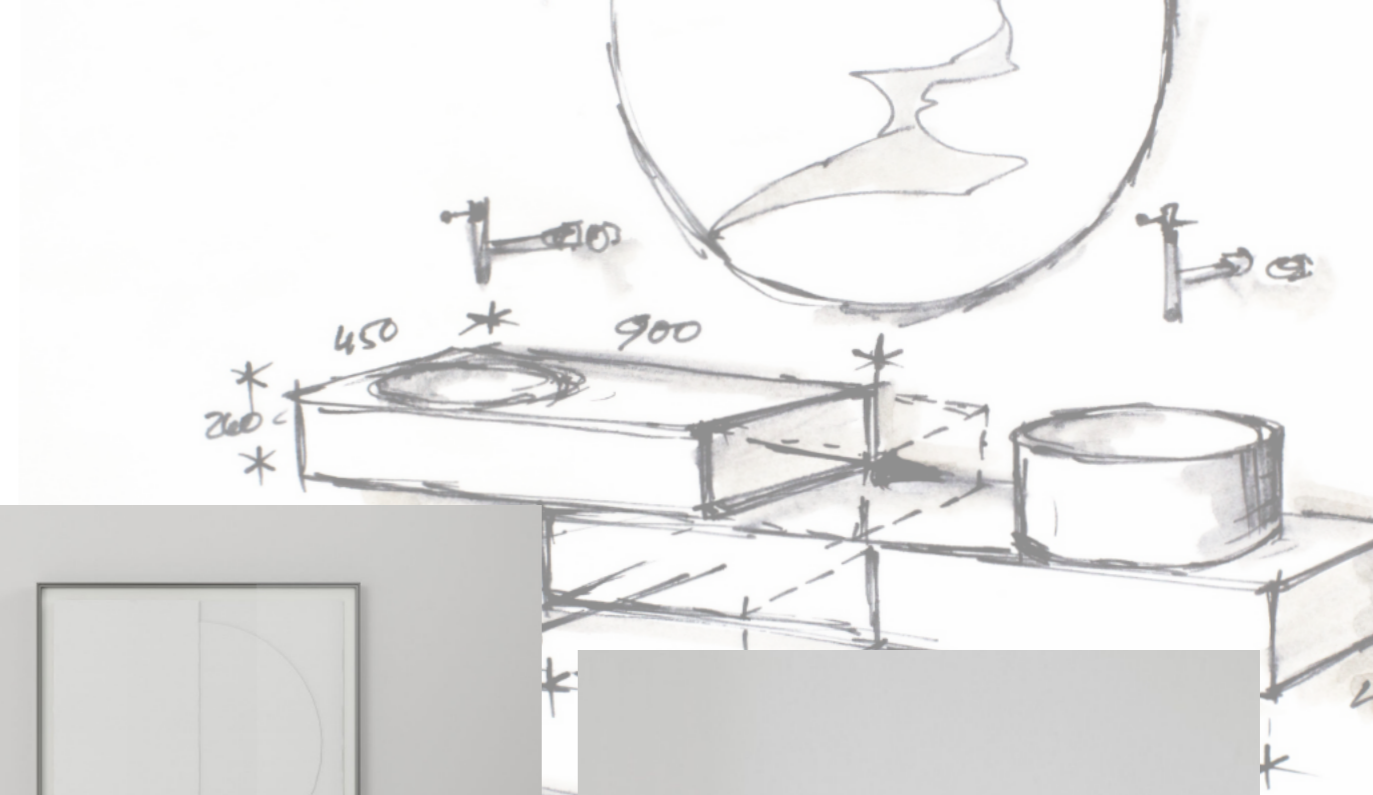

SQ1  
BATHTUB



Scandinavian simplicity, straight lines and organic soft shapes.  
A pleasure to look at and an even greater pleasure to use.



SQ1 bathtub // matte white Acovi®

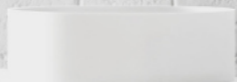

# SQ1 OVAL

BATHTUB



SQ1 oval // matte white Acovi®



Scandinavian design with clean lines.  
Made for optimal comfort with ergonomic shapes on the inside.



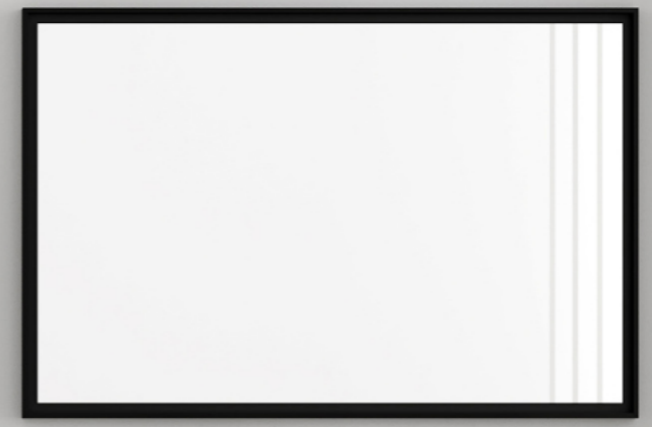

# MUSCHEL

BATHTUB



Muschel // matte white Acovi®



Inspired by seashells from the beautiful Danish west coast, the Muschel bathtub has a unique natural design.



TQ5  
BATHTUB



TQ5 bathtub has a modern yet classic look.  
Extra high sides and soft organic shapes for maximum comfort.



TQ5 // matte white Acovi®





Christianssand // matte white Acovi®



Classic straight lines with an integrated towel rack.  
The ergonomic bottom gives your back perfect support.

YUNO DESIGN  
GERMANY

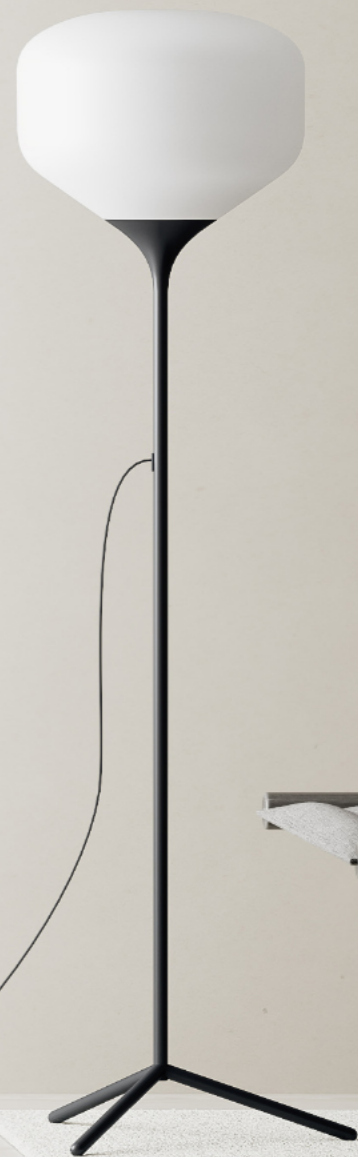



# YUNO DESIGN

MANNHEIM / GERMANY



Lena Billmeier and David Baur joint forces and founded their own product design studio in 2012. Important within their work is to create simple and timeless yet

emotional products, with a strong and distinctive brand image. Working hands-on with mock-ups, prototypes and experimenting with materials is a vital part in their design process. In combining their german roots with global influences they aim to challenge themselves to create fresh, innovative and beautiful design projects.

YUNO is known worldwide for their unique designs and functionality in there products.

They are designing products by understanding and meeting peoples needs. They believe that thoughtful design can make a difference, that it gives the consumer experience an extra touch.

## AWARDS

CES Honoree 2016

Winner - red dot design award 2017

Gold - German Design Award 2018

German Design Award 2018

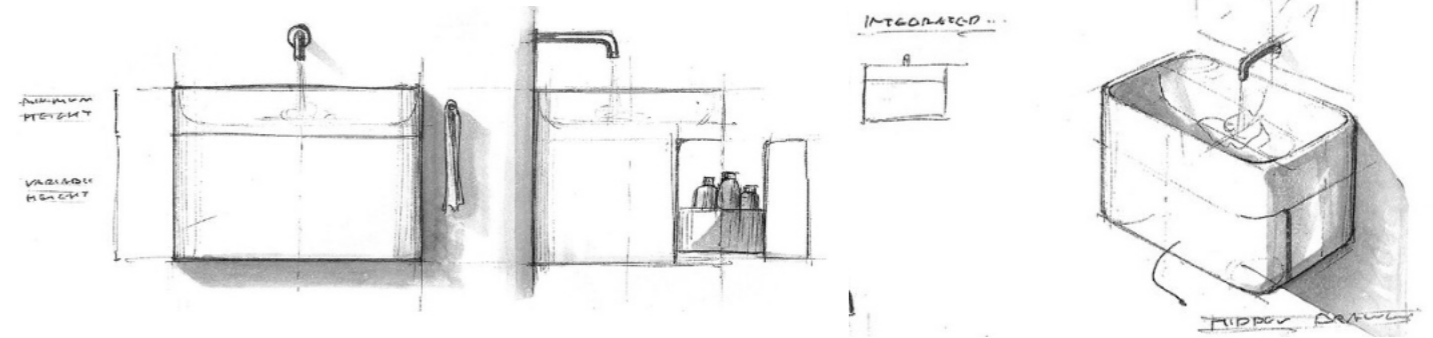

# YUNO CA

BASIN



Unique basin with roomy drawer, perfect for storage.  
Made with high quality BLUM runners.



Yuno CA // matte white Acovi®



YUNO LR  
BASIN



Yuno LR // matte white Acovi®



Yuno LR with ledge for soap or a faucetet.  
Can be mounted left or right



# YUNO TA

BASIN



Yuno TA // matte white Acovi®



Elegant free standing basin.  
Can be mounted on countertops or vanity units.



# YUNO WA

BASIN



Yuno WA // matte white Acovi®



Small and elegant wall mounted basin with ledge,  
when space is limited.



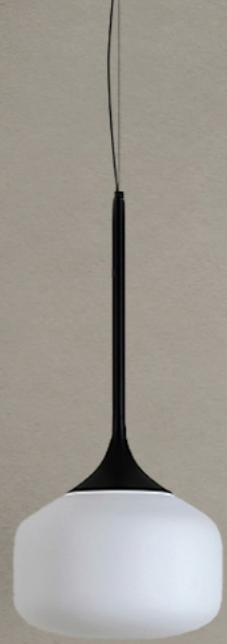

# YUNO RAIL

BASIN



Yuno Rail // matte white Acovi®



Yuno basin with towel rack made of stainless steel.



# YUNO BATHTUB



Yuno bathtub made with ergonomic shapes and integrated shelf.



Yuno Bathtub // matte white Acovi®



# SKAGEN

CABINET



Ceramic tiles with stylish and modern marble look.  
Solid oak drawers with runners from BLUM and integrated LED light.

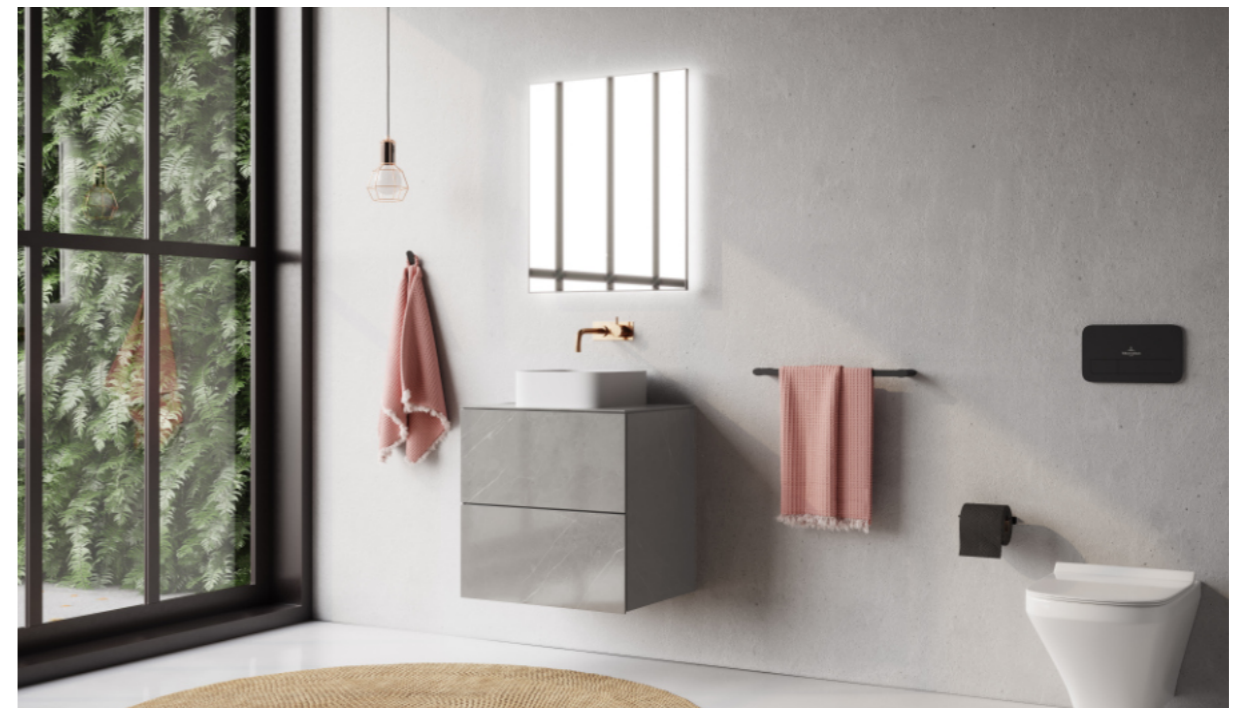

Skagen // ceramic tiles



# BERGEN

CABINET



Bergen // brushed oak



Beautiful cabinet in brushed oak  
Add extra inner drawer for maximum storage.



## SPECIFICATIONS

## SPECIFICATIONS

### CHRISTIANSAND BASIN RIGHT

Matte white Acovi® composite  
H/W/D: 30/80/40 cm  
SKU: 40010144

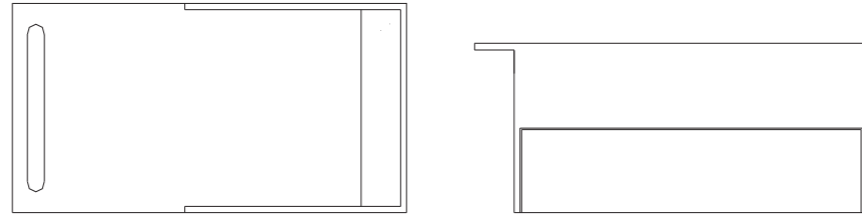

### CHRISTIANSAND BASIN LEFT

Matte white Acovi® composite  
H/W/D: 30/80/40 cm  
SKU: 40010112

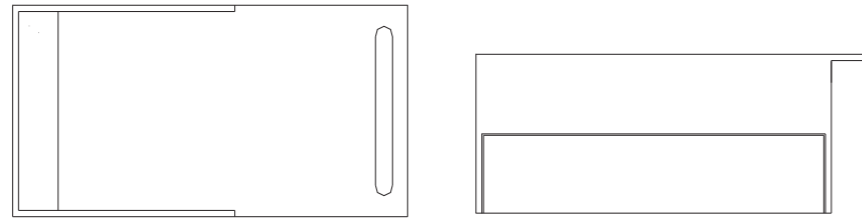

### CHRISTIANSSAND BATHTUB

Matte white Acovi® composite  
H/W/D: 55/190/80 cm  
SKU: 40030015

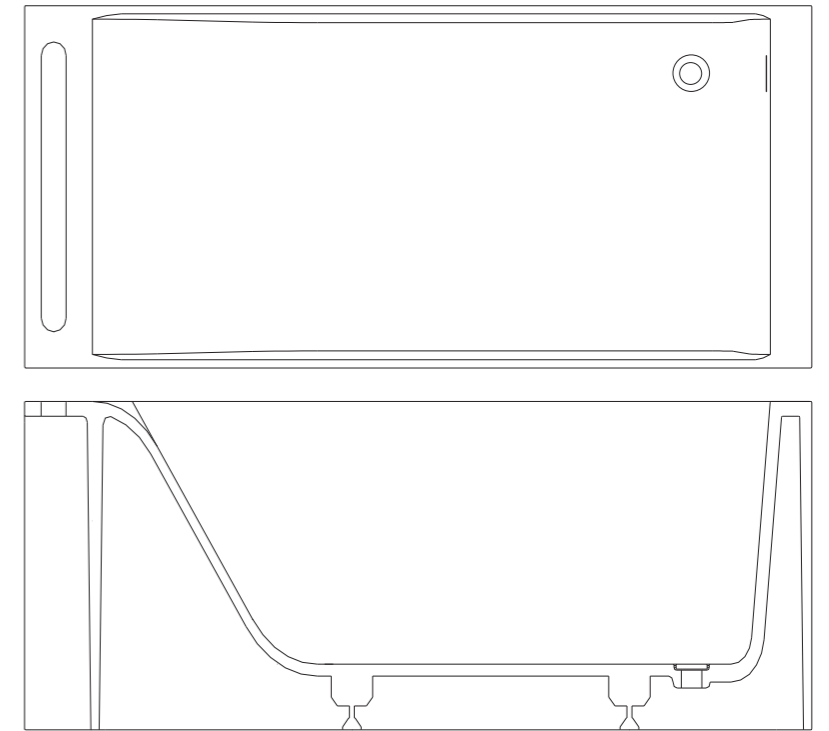

### YUNO BATHTUB

Matte white Acovi® composite  
H/W/D: 75/180/90 cm  
SKU: 40030047

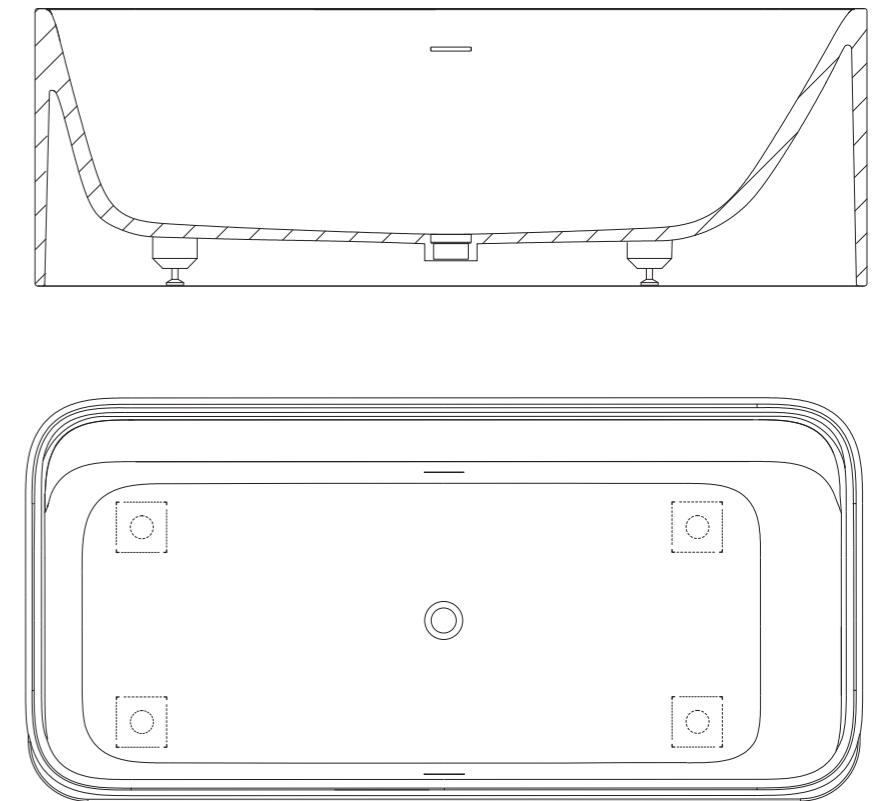

## SPECIFICATIONS

### SQ1 BATHTUB

Matte white Acovi® composite  
H/W/D: 55/170/71  
SKU: 40030034

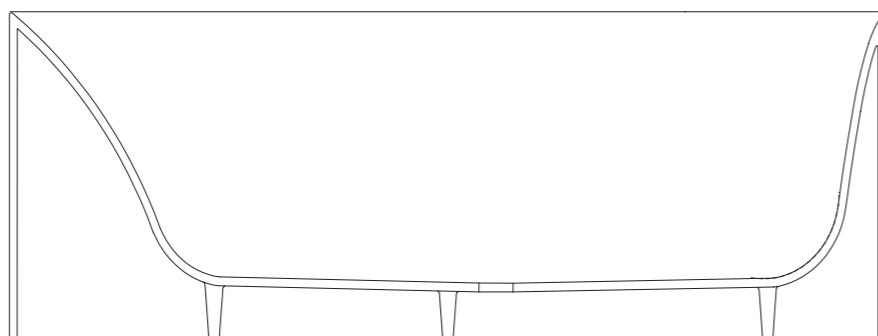
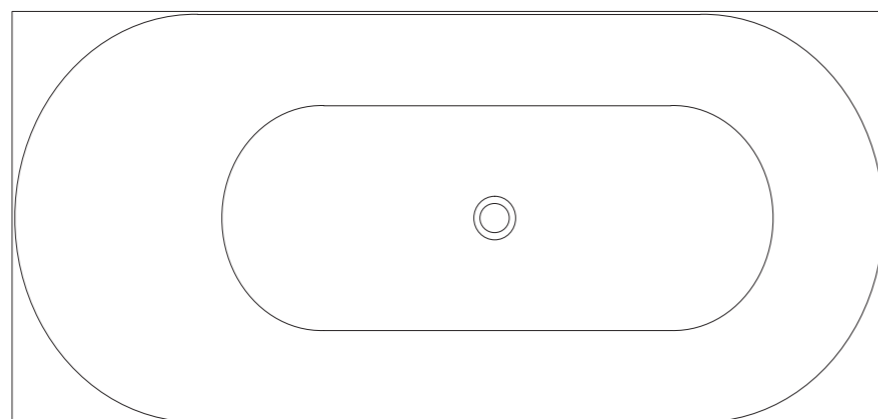

### SQ1 OVAL BATHTUB

Matte white Acovi® composite  
H/W/D: 55/169,5/71  
SKU: 40030041

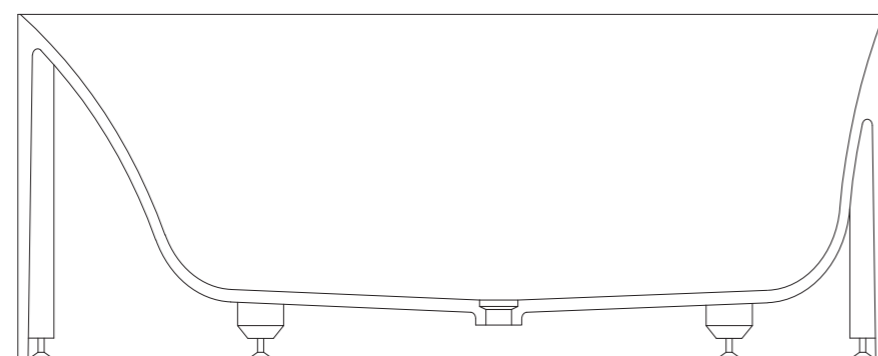
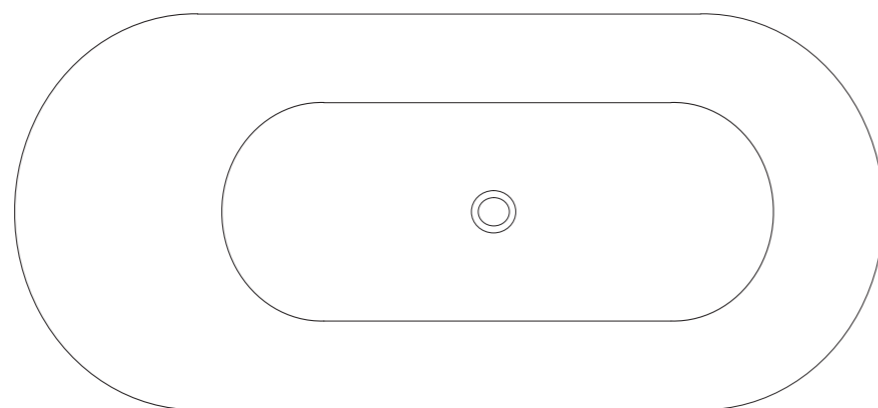

### TQ5 BATHTUB

Matte white Acovi® composite  
H/W/D: 62/159/75  
SKU: 40030045

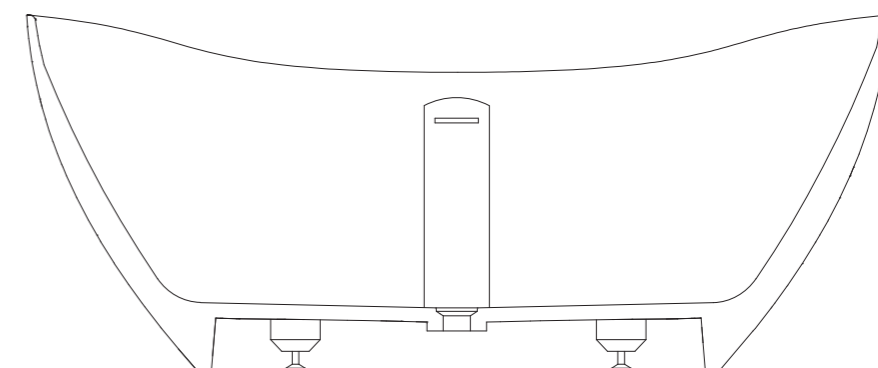
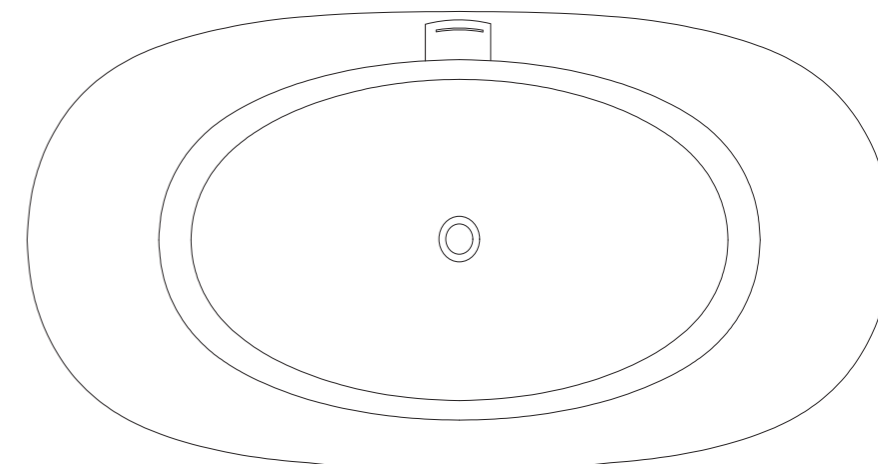

### MUSCHEL BATHTUB

Matte white Acovi® composite  
H/W/D: 55/175/98  
SKU: 40030040

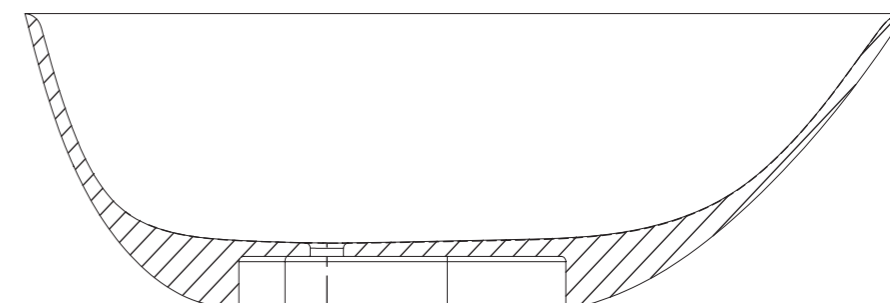
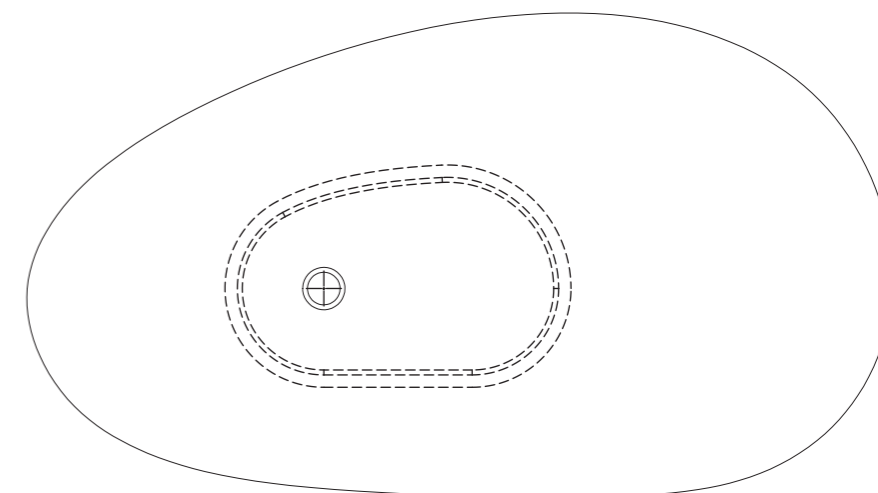

## SPECIFICATIONS

### SQ2 60 CABINET

Matte white PU lacquered MDF + Acovi® composite  
H/W/D: 28,8/60/45 cm  
SKU: 30010230



### SQ2 80 CABINET

Matte white PU lacquered MDF + Acovi® composite  
H/W/D: 28,8/80/45  
SKU: 30010132



### SQ2 100 CABINET

Matte white PU lacquered MDF + Acovi® composite  
H/W/D: 28,8/100/45  
SKU: 30010234

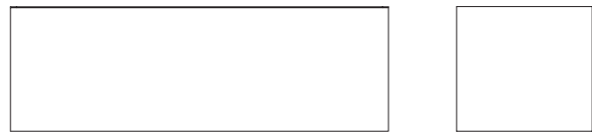

### SQ2 120 CABINET

Matte white PU lacquered MDF + Acovi® composite  
H/W/D: 28,8/120/45  
SKU: 30010236

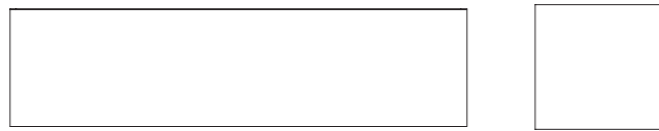

### SQ2 160 CABINET

Matte white PU lacquered MDF + Acovi® composite  
H/W/D: 28,8/160/45  
SKU: 30010125



### SQ2 60 DOUBLE CABINET

PU lacquered MDF + Acovi® composite  
H/W/D: 60/60/45  
SKU: 30010106

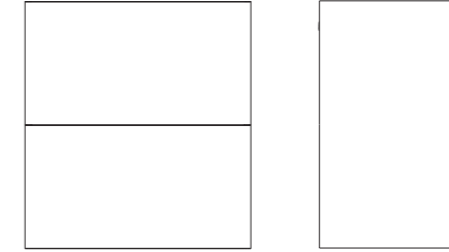

### SQ2 80 DOUBLE CABINET

Matte white PU lacquered MDF + Acovi® composite  
H/W/D: 60/80/45  
SKU: 30010121



### SQ2 100 DOUBLE CABINET

Matte white PU lacquered MDF + Acovi® composite  
H/W/D: 60/100/45  
SKU: 30010235



### SQ2 120 DOUBLE CABINET

Matte white PU lacquered MDF + Acovi® composite  
H/W/D: 60/120/45  
SKU: 30010169



### SQ2 160 DOUBLE CABINET

Matte white PU lacquered MDF + Acovi® composite  
H/W/D: 60/160/45  
SKU: 30010245



SQ2 120 cabinet & SQ2 120 double cabinet - Available with left, right, centre or double basin

SQ2 160 cabinet & SQ2 160 double cabinet - Available with left, right or double basin

All cabinets can be combined with SQ integrated basin or a table top with free standing basin on top.

Please note that the cabinets need a special membrane trap (Copenhagen Bath Senzo trap, 40040094)

## SPECIFICATIONS

### YUNO TA 34

Matte white Acovi® composite  
H/W/D: 11/34/34 cm  
SKU: 40010222

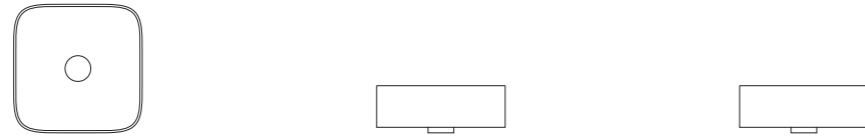

### YUNO TA 55

Matte white Acovi® composite  
H/W/D: 11/55/34 cm  
SKU: 40010219

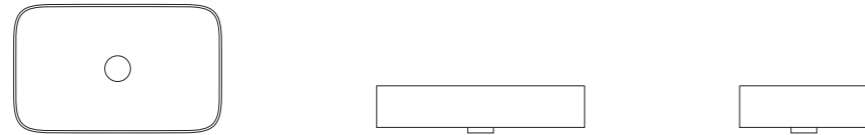

### YUNO WA 41

Matte white Acovi® composite  
H/W/D: 11/41/41 cm  
SKU: 40010223

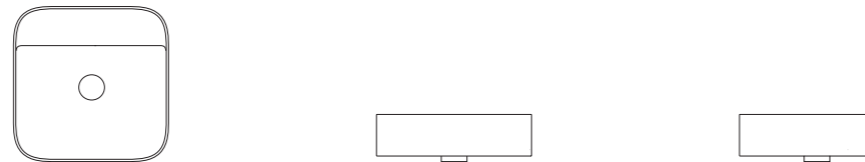

### YUNO WA 55

Matte white Acovi® composite  
H/W/D: 11/55/41 cm  
SKU: 40010218

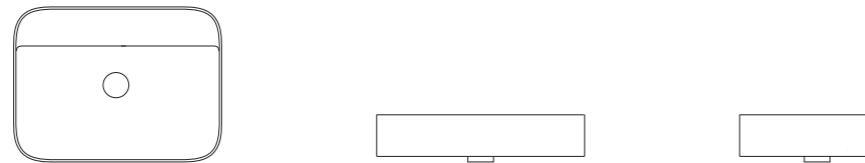

### YUNO WA 80

Matte white Acovi® composite  
H/W/D: 11/80/41 cm  
SKU: 40010224

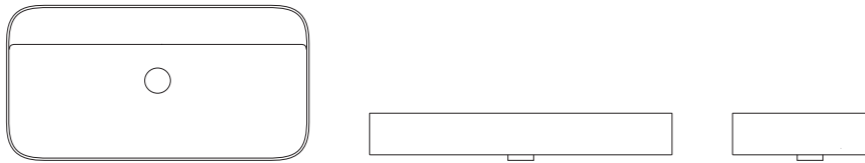

### YUNO CA 41

Matte white Acovi® composite  
H/W/D: 30/41/41 cm  
SKU: 40010220

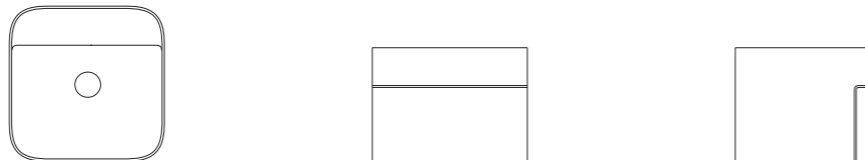

### YUNO CA 55

Matte white Acovi® composite  
H/W/D: 30/55/41 cm  
SKU: 40010216

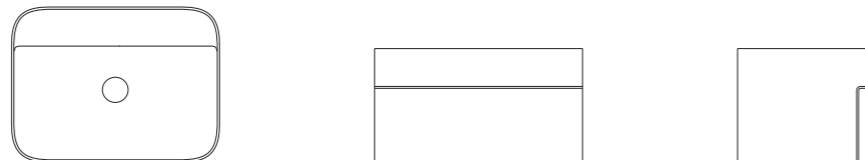

### YUNO CA 80

Matte white Acovi® composite  
H/W/D: 30/80/41 cm  
SKU: 40010217

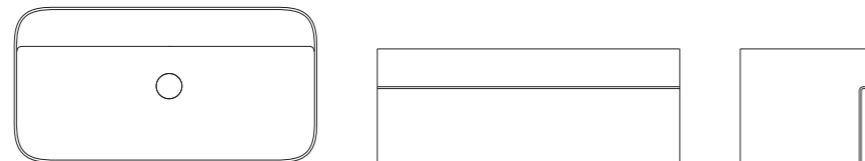

### YUNO LR 41

Matte white Acovi® composite  
H/W/D: 11/41/24 cm  
SKU: 40010225

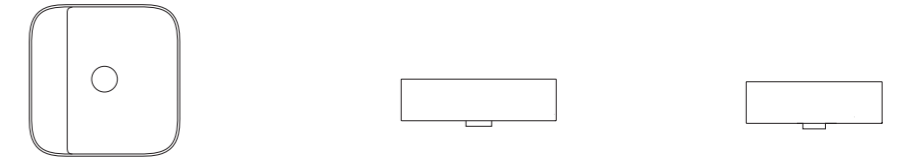

### YUNO LR 55

Matte white Acovi® composite  
H/W/D: 11/55/30 cm  
SKU: 40010226

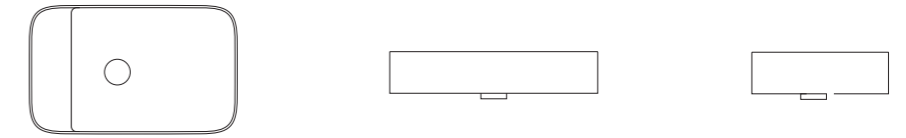

### YUNO LR 80

Matte white Acovi® composite  
H/W/D: 11/80/20 cm  
SKU: 40010227



### YUNO RAIL 41

Matte white Acovi® composite  
H/W/D: 30/41/24 cm  
SKU: 40010228

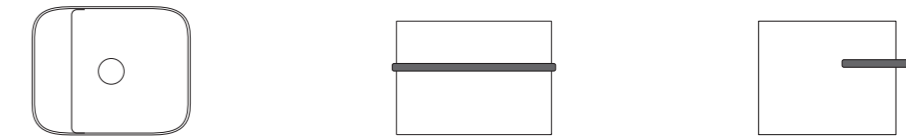

### YUNO RAIL 55

Matte white Acovi® composite  
H/W/D: 30/55/31 cm  
SKU: 40010229

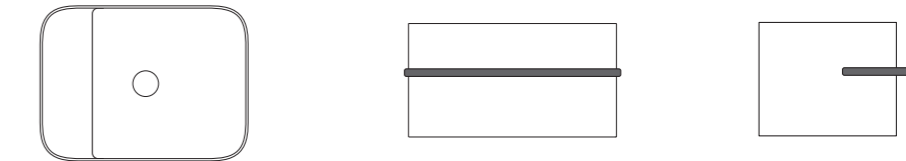

### YUNO RAIL 80

Matte white Acovi® composite  
H/W/D: 30/80/20 cm  
SKU: 40010230

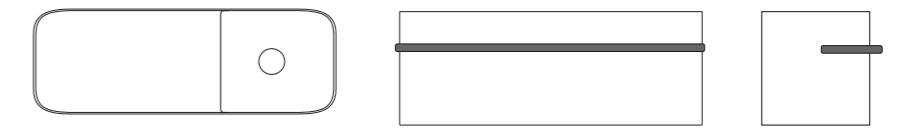

TA - Table mounted (Hole for drain should be 80 mm).

WA - Wall mounted. Brackets included.

CA - Basin with drawer. Brackets included.

LR - Left or right wall mounted basin. Brackets included.

RAIL - Wall mounted basin with towel rack. Brackets included.

All basins are exclusive faucet, waste and trap.

Please note that the CA models need a special membrane trap (Copenhagen Bath Senzo trap, 40040094)

## SPECIFICATIONS

### SKAGEN 60 CABINET

Ceramic tiles and brushed oak  
H/W/D: 30/60/45  
SKU: 30010155



### SKAGEN 60 DOUBLE CABINET

Ceramic tiles and brushed oak  
H/W/D: 60/60/45  
SKU: 30010180

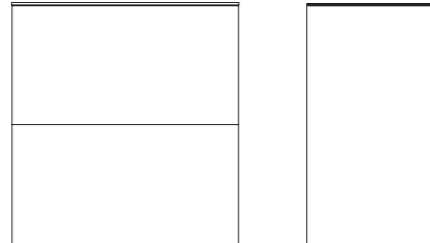

### SKAGEN 80 CABINET

Ceramic tiles and brushed oak  
H/W/D: 30/80/45  
SKU: 30010156



### SKAGEN 80 DOUBLE CABINET

Ceramic tiles and brushed oak  
H/W/D: 60/80/45  
SKU: 30010181

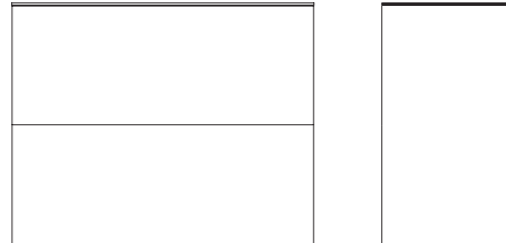

### SKAGEN 100 CABINET

Ceramic tiles and brushed oak  
H/W/D: 30/100/45  
SKU: 30010157



### SKAGEN 120 CABINET

Ceramic tiles and brushed oak  
H/W/D: 30/120/45  
SKU: 30010179



### SKAGEN 120 DOUBLE CABINET

Ceramic tiles and brushed oak  
H/W/D: 60/120/45  
SKU: 30010214

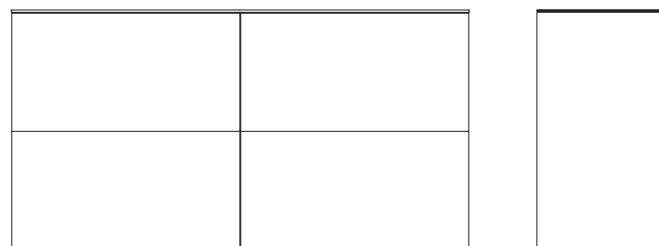

### SKAGEN 160 CABINET

Ceramic tiles and brushed oak  
H/W/D: 30/160/45  
SKU: 30010176



### SKAGEN 160 DOUBLE CABINET

Ceramic tiles and brushed oak  
H/W/D: 60/160/45  
SKU: 30040129

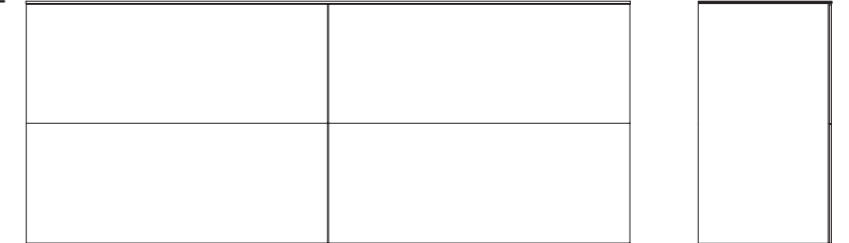

### BERGEN 80 CABINET

Brushed oak  
H/W/D: 40/80/50  
SKU: 30010099



### BERGEN 120 CABINET

Brushed oak  
H/W/D: 40/120/50  
SKU: 30010100



### BERGEN 160 CABINET

Brushed oak  
H/W/D: 40/160/50  
SKU: 30010101



### BERGEN 200 CABINET

Brushed oak  
H/W/D: 40/200/50  
SKU: 30010102

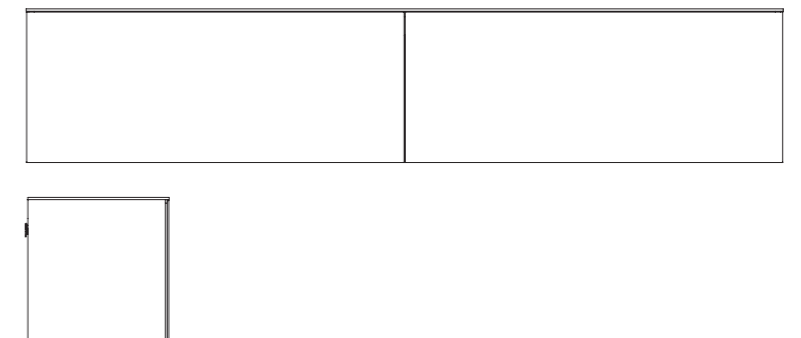

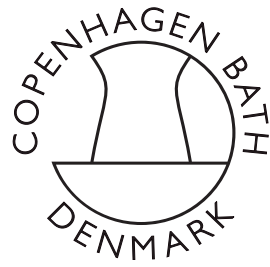

TIME FOR YOU

10 year  
guarantee  
Acovi®

timeless  
danish  
design

made  
to  
measure

[COPENHAGENBATH.COM](http://COPENHAGENBATH.COM)